



Grayhill, Inc.

62S11-M5-020CH

Part Number: 62S11-M5-020CH

Fabrikant / Brand: Grayhill, Inc.

Produkt beschreibung: ROTARY ENCODER OPTICAL 32PPR

Datebanken: [PDF 62S11-M5-020CH.pdf](#)RoHS Status:  Bleif gratis / RoHS kompatibel

Ship From: Hong Kong

Shipment Way: DHL/Fedex/TNT/UPS/EMS





Bild kann Representatioun sinn. Kuckt Spezifikatioune fir Produktdetailer.





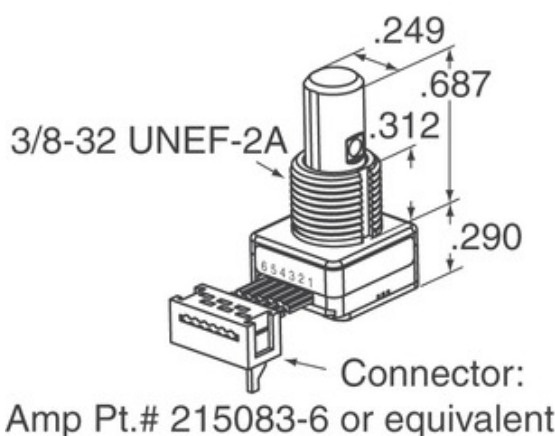

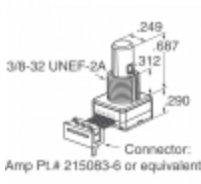

Spezifikatioune vun 62S11-M5-020CH

PART NUMBER	62S11-M5-020CH
HIERSTELLER	Grayhill, Inc.
BESCHREIWUNG	ROTARY ENCODER OPTICAL 32PPR
BLEIF FREE STATUS / ROHS STATUS	Bleif gratis / RoHS kompatibel
DATENLABEL	PDF 62S11-M5-020CH.pdf
VOLTAGE - SUPPLY	5V
TERMINATIOUNSTIL	Cable with Connector
SERIE	62S
ROTATIONAL LIFE (CYCLES MIN)	1M
IMPULSEN PRO REVOLUTIOUN	32
AUSGÄNGEGKEET	Quadrature (Incremental)
ANER NAMES	62S11M5020CH
ORIENTÉIERUNG	Vertical
MOUNTING TYPE	Panel Mount
FEUCHTIGKEIT SENSIBILITÉITNIVEAU (MSL)	1 (Unlimited)
FABRIK STANDARD LEAD TIME	8 Weeks
BLEIF FREE STATUS / ROHS STATUS	Lead free / RoHS Compliant
ENCODER TYPE	Optical
PRËT	Yes
BUILT AM SCHALTER	Yes
AKTUATOR TYPE	1/4" Dia Flatted End

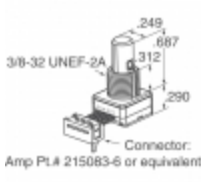
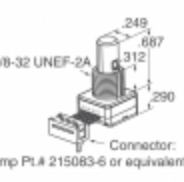
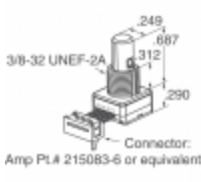
Verbonnen Tags

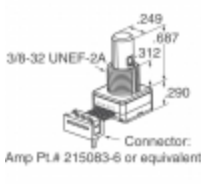
Grayhill, Inc. 62S11-M5-020CH	62S11-M5-020CH Distributeur	62S11-M5-020CH Ubidder
62S11-M5-020CH Präis	62S11-M5-020CH Fotoen	62S11-M5-020CH Bild
62S11-M5-020CH PDF Dateblatt	62S11-M5-020CH Luet Dateblatt	62S11-M5-020CH Dateblatt
62S11-M5-020CH Stock	Kaaft 62S11-M5-020CH	Kaaft Grayhill, Inc. 62S11-M5-020CH
Grayhill, Inc. 62S11-M5-020CH	Grayhill, Inc. Ubidder	Grayhill, Inc. Distributeur
Grayhill, Inc. 62S11-M5-020CH	Grayhill Inc. 62S11-M5-020CH	

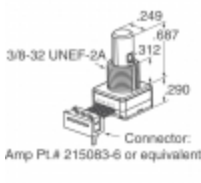
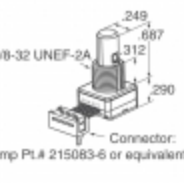
Verbonnen Produkter

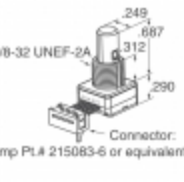
 <p>62S11-M5-040C Produzenteuren: Grayhill, Inc. Beschreibung: ROTARY ENCODER OPTICAL 32PPR Op Lager: Out stock RFQ</p>	 <p>62S11-M5-020C Produzenteuren: Grayhill, Inc. Beschreibung: ROTARY ENCODER OPT 32PPR 2" CBL Op Lager: Out stock RFQ</p>
 <p>62S11-M0-PV Produzenteuren: Grayhill, Inc. Beschreibung: ROTARY ENCODER OPTICAL 32PPR Op Lager: Out stock RFQ</p>	 <p>62S11-M5-030CH Produzenteuren: Grayhill, Inc. Beschreibung: ROTARY ENCODER OPTICAL 32PPR Op Lager: Out stock RFQ</p>
 <p>62S11-M0-200S Produzenteuren: Grayhill, Inc. Beschreibung: ROTARY ENCODER OPTICAL 32PPR Op Lager: Out stock RFQ</p>	 <p>62S11-M5-050C Produzenteuren: Grayhill, Inc. Beschreibung: ROTARY ENCODER OPT 32PPR 5" CBL Op Lager: 558 pcs RFQ</p>
 <p>62S11-M5-030C Produzenteuren: Grayhill, Inc. Beschreibung: ROTARY ENCODER OPTICAL 32PPR Op Lager: Out stock RFQ</p>	 <p>62S11-M0-210SH Produzenteuren: Grayhill, Inc. Beschreibung: ROTARY ENCODER OPT 32PPR 20" CBL Op Lager: Out stock RFQ</p>
 <p>62S11-M5-020S Produzenteuren: Grayhill, Inc. Beschreibung: ROTARY ENCODER OPTICAL 32PPR Op Lager: Out stock RFQ</p>	 <p>62S11-M5-020SH Produzenteuren: Grayhill, Inc. Beschreibung: ROTARY ENCODER OPT 32PPR 2" CBL Op Lager: Out stock RFQ</p>
 <p>62S11-M0-P Produzenteuren: Grayhill, Inc. Beschreibung: ROTARY ENCODER OPTICAL 32PPR Op Lager: Out stock RFQ</p>	 <p>62S11-M0-PH Produzenteuren: Grayhill, Inc. Beschreibung: ROTARY ENCODER OPTICAL 32PPR Op Lager: Out stock RFQ</p>