

Panasonic

Panasonic

ARXP1003

Part Number:

ARXP1003

Fabrikant / Brand:

Panasonic

Produkt beschreibung:

RELAY RF SPDT 500MA 3V

Datebanken:

 ARXP1003.pdf

RoHS Status:

 Bleif gratis / RoHS kompatibel

Ship From:

Hong Kong

Shipment Way:

DHL/Fedex/TNT/UPS/EMS



Bild kann Representatioun sinn. Kuckt Spezifikatioune fir Produktdetailer.

UFRO FIR ZITAT





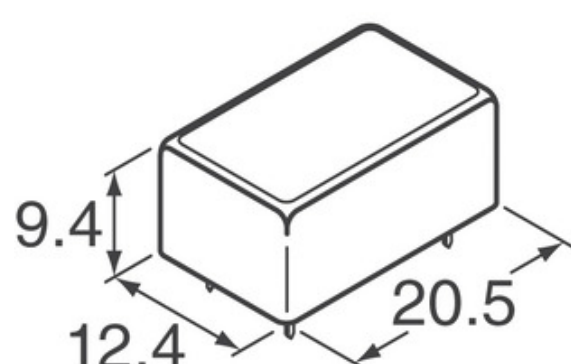



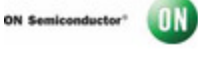

Spezifikatioune vun ARXP1003

PART NUMBER	ARXP1003
HIERSTELLER	Panasonic
BESCHREIWUNG	RELAY RF SPDT 500MA 3V
BLEIF FREE STATUS / ROHS STATUS	Bleif gratis / RoHS kompatibel
DATENLABEL	 ARXP1003.pdf
SPÉIT ON DER VOLTAGE (MAX)	2.25 VDC
OFF-SPANNUNG (MIN)	0.3 VDC
TERMINATIOUNSTIL	PC Pin
SPANNUNG	30VDC - Max
SERIE	ARXP
RELEASE TIME	6ms
VERPAKUNG	Tube
ANER NAMES	255-2718
OPERATIOUN TEMPERATUR	-40°C ~ 70°C
OPERATE TIME	10ms
MOUNTING TYPE	Through Hole
FEUCHTIGKEIT SENSIBILITÉITNIVEAU (MSL)	1 (Unlimited)
BLEIF FREE STATUS / ROHS STATUS	Lead free / RoHS Compliant
EESCHAFTEN	-
KONTAKTLËSCHT (AKTUELL)	500mA
KONTAKT MATERIAL	Gold Plating
KONTAKTFORMULAR	SPDT (1 Form C)
SPUIDSPANNUNG	3VDC
COIL TYPE	Non Latching
COIL RESISTANCE	45 Ohms
COIL POWER	200 mW
COIL CURRENT	66.7mA

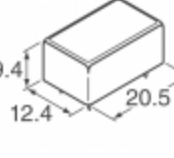
Verbonnen Tags

Panasonic ARXP1003	ARXP1003 Distributeur	ARXP1003 Ubidder
ARXP1003 Präis	ARXP1003 Fotoen	ARXP1003 Bild
ARXP1003 PDF Dateblatt	ARXP1003 Luet Dateblatt	ARXP1003 Dateblatt
ARXP1003 Stock	Kaaft ARXP1003	Kaaft Panasonic ARXP1003
Panasonic ARXP1003	Panasonic Ubidder	Panasonic Distributeur
Panasonic ARXP1003	Panasonic - Consumer Division ARXP1003	Panasonic - Consumer Electronics Corp. ARXP1003
Panasonic Battery Group ARXP1003	Panasonic Electric Works - ACSD ARXP1003	Panasonic Electronic Components - Semiconductor Pr ARXP1003
Panasonic - ATG ARXP1003	Panasonic - BSG ARXP1003	Panasonic - DTG ARXP1003
Panasonic Electric Works ARXP1003	Panasonic Electronic Components ARXP1003	Panasonic Industrial Automation Sales ARXP1003
Panasonic Semiconductor ARXP1003		

Verbonnen Produkter

 <p>ARX550AT2C00XPEAH-S216-GEVB Produzenteuren: AMI Semiconductor / ON Semiconductor Beschreibung: BOARD EVAL VGA 1/5" CIS HB Op Lager: Out stock RFQ</p>	 <p>ARX550AT2R00XPEAH-GEVB Produzenteuren: AMI Semiconductor / ON Semiconductor Beschreibung: BOARD EVAL WPGA 1/4" CIS HB Op Lager: Out stock RFQ</p>
 <p>ARXP1024 Produzenteuren: Panasonic Beschreibung: RELAY RF SPDT 500MA 24V Op Lager: Out stock RFQ</p>	 <p>ARX550HDSC00XPEAH-GEVB Produzenteuren: AMI Semiconductor / ON Semiconductor Beschreibung: BOARD EVAL VGA 1/5" CIS HB Op Lager: Out stock RFQ</p>
 <p>ARXP1009 Produzenteuren: Panasonic Beschreibung: RELAY RF SPDT 500MA 9V Op Lager: Out stock RFQ</p>	 <p>ARX550AT2C00XPEAH-GEVB Produzenteuren: AMI Semiconductor / ON Semiconductor Beschreibung: BOARD EVAL VGA 1/5" CIS HB Op Lager: Out stock RFQ</p>
 <p>ARXP1012 Produzenteuren: Panasonic Beschreibung: RELAY RF SPDT 500MA 12V Op Lager: Out stock RFQ</p>	 <p>ARXP1103 Produzenteuren: Panasonic Beschreibung: RELAY RF SPDT 500MA 3V Op Lager: Out stock RFQ</p>
 <p>ARX124H Produzenteuren: Panasonic Beschreibung: RELAY RF SPDT 500MA 4.5V Op Lager: Out stock RFQ</p>	 <p>ARXP104H Produzenteuren: Panasonic Beschreibung: RELAY RF SPDT 500MA 4.5V Op Lager: Out stock RFQ</p>
 <p>ARXP1006 Produzenteuren: Panasonic Beschreibung: RELAY RF SPDT 500MA 6V Op Lager: Out stock RFQ</p>	 <p>ARX550HDSC00XPEA0-DRBR1 Produzenteuren: AMI Semiconductor / ON Semiconductor Beschreibung: IMAGE SENSOR VGA 1/5 CIS Op Lager: Out stock RFQ</p>