

**TrenchT2™ Power
MOSFET**
**IXTH360N055T2
IXTT360N055T2**

$$V_{DSS} = 55V$$

$$I_{D25} = 360A$$

$$R_{DS(on)} \leq 2.4m\Omega$$

N-Channel Enhancement Mode
Avalanche Rated
Fast Intrinsic Diode

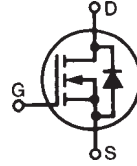

| Symbol | Test Conditions | Maximum Ratings | |
|------------|---|-----------------|------------|
| V_{DSS} | $T_J = 25^\circ C$ to $175^\circ C$ | 55 | V |
| V_{DGR} | $T_J = 25^\circ C$ to $175^\circ C$, $R_{GS} = 1M\Omega$ | 55 | V |
| V_{GSM} | Transient | ± 20 | V |
| I_{D25} | $T_C = 25^\circ C$ (Chip Capability) | 360 | A |
| I_{LRMS} | Lead Current Limit, RMS | 160 | A |
| I_{DM} | $T_C = 25^\circ C$, Pulse Width Limited by T_{JM} | 900 | A |
| I_A | $T_C = 25^\circ C$ | 180 | A |
| E_{AS} | $T_C = 25^\circ C$ | 960 | mJ |
| P_D | $T_C = 25^\circ C$ | 935 | W |
| T_J | | -55 ... +175 | $^\circ C$ |
| T_{JM} | | 175 | $^\circ C$ |
| T_{stg} | | -55 ... +175 | $^\circ C$ |
| T_L | 1.6mm (0.062in.) from Case for 10s | 300 | $^\circ C$ |
| T_{sold} | Plastic Body for 10 seconds | 260 | $^\circ C$ |
| M_d | Mounting Torque (TO-247) | 1.13 / 10 | Nm/lb.in. |
| Weight | TO-247 | 6 | g |
| | TO-268 | 4 | g |

| Symbol | Test Conditions ($T_J = 25^\circ C$ Unless Otherwise Specified) | Characteristic Values | | |
|--------------|---|-----------------------|------|----------------|
| | | Min. | Typ. | Max. |
| BV_{DSS} | $V_{GS} = 0V$, $I_D = 250\mu A$ | 55 | | V |
| $V_{GS(th)}$ | $V_{DS} = V_{GS}$, $I_D = 250\mu A$ | 2.0 | | V |
| I_{GSS} | $V_{GS} = \pm 20V$, $V_{DS} = 0V$ | | | ± 200 nA |
| I_{DSS} | $V_{DS} = V_{DSS}$, $V_{GS} = 0V$ $T_J = 150^\circ C$ | | | 10 μA |
| | | | | 300 μA |
| $R_{DS(on)}$ | $V_{GS} = 10V$, $I_D = 100A$, Note 1 | | | 2.4 m Ω |

TO-247 (IXTH)

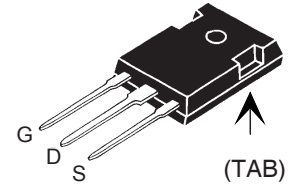

TO-268 (IXTT)

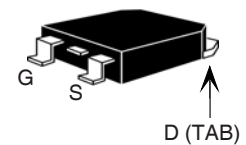

G = Gate D = Drain
S = Source TAB = Drain

Features

- International Standard Package
- $175^\circ C$ Operating Temperature
- High Current Handling Capability
- Avalanche Rated
- Fast Intrinsic Diode
- Low $R_{DS(on)}$

Advantages

- Easy to Mount
- Space Savings
- High Power Density

Applications

- DC/DC Converters and Off-line UPS
- Primary- Side Switch
- High Current Switching Applications

| Symbol | Test Conditions ($T_J = 25^\circ\text{C}$, Unless Otherwise Specified) | Characteristic Values | | |
|--------------|--|-----------------------|------|------------------------|
| | | Min. | Typ. | Max. |
| g_{fs} | $V_{DS} = 10\text{V}$, $I_D = 60\text{A}$, Note 1 | 65 | 110 | S |
| C_{iss} | $V_{GS} = 0\text{V}$, $V_{DS} = 25\text{V}$, $f = 1\text{MHz}$ | | 20 | nF |
| C_{oss} | | | 2650 | pF |
| C_{rss} | | | 480 | pF |
| R_{Gi} | Gate Input Resistance | | 1.6 | Ω |
| $t_{d(on)}$ | Resistive Switching Times $V_{GS} = 10\text{V}$, $V_{DS} = 0.5 \cdot V_{DSS}$, $I_D = 100\text{A}$ $R_G = 2\Omega$ (External) | | 30 | ns |
| t_r | | | 23 | ns |
| $t_{d(off)}$ | | | 62 | ns |
| t_f | | | 56 | ns |
| $Q_{g(on)}$ | $V_{GS} = 10\text{V}$, $V_{DS} = 0.5 \cdot V_{DSS}$, $I_D = 0.5 \cdot I_{D25}$ | | 330 | nC |
| Q_{gs} | | | 76 | nC |
| Q_{gd} | | | 87 | nC |
| R_{thJC} | | | | 0.16°C/W |
| R_{thCH} | TO-247 | 0.21 | | $^\circ\text{C/W}$ |

Source-Drain Diode

| Symbol | Test Conditions ($T_J = 25^\circ\text{C}$, Unless Otherwise Specified) | Characteristic Values | | |
|----------|--|-----------------------|------|--------|
| | | Min. | Typ. | Max. |
| I_S | $V_{GS} = 0\text{V}$ | | | 360 A |
| I_{SM} | Repetitive, Pulse Width Limited by T_{JM} | | | 1440 A |
| V_{SD} | $I_F = 100\text{A}$, $V_{GS} = 0\text{V}$, Note 1 | | | 1.3 V |
| t_{rr} | $I_F = 150\text{A}$, $V_{GS} = 0\text{V}$ $-di/dt = 100\text{A}/\mu\text{s}$ $V_R = 27\text{V}$ | | 78 | ns |
| I_{RM} | | | 4.2 | A |
| Q_{RM} | | | 164 | nC |

Note 1. Pulse test, $t \leq 300\mu\text{s}$; duty cycle, $d \leq 2\%$.

PRELIMINARY TECHNICAL INFORMATION

The product presented herein is under development. The Technical Specifications offered are derived from data gathered during objective characterizations of preliminary engineering lots; but also may yet contain some information supplied during a pre-production design evaluation. IXYS reserves the right to change limits, test conditions, and dimensions without notice.

TO-247 (IXTH) Outline

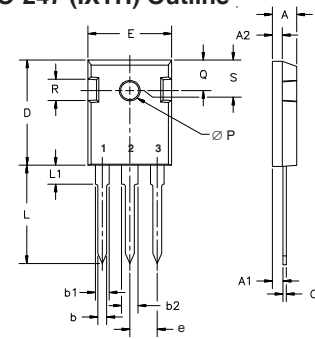

Terminals: 1 - Gate 2 - Drain
3 - Source Tab - Drain

| Dim. | Millimeter | | Inches | |
|----------------|------------|-------|--------|-------|
| | Min. | Max. | Min. | Max. |
| A | 4.7 | 5.3 | .185 | .209 |
| A ₁ | 2.2 | 2.54 | .087 | .102 |
| A ₂ | 2.2 | 2.6 | .059 | .098 |
| b | 1.0 | 1.4 | .040 | .055 |
| b ₁ | 1.65 | 2.13 | .065 | .084 |
| b ₂ | 2.87 | 3.12 | .113 | .123 |
| C | .4 | .8 | .016 | .031 |
| D | 20.80 | 21.46 | .819 | .845 |
| E | 15.75 | 16.26 | .610 | .640 |
| e | 5.20 | 5.72 | 0.205 | 0.225 |
| L | 19.81 | 20.32 | .780 | .800 |
| L ₁ | | 4.50 | | .177 |
| ∅P | 3.55 | 3.65 | .140 | .144 |
| Q | 5.89 | 6.40 | 0.232 | 0.252 |
| R | 4.32 | 5.49 | .170 | .216 |
| S | 6.15 | BSC | 242 | BSC |

TO-268 Outline

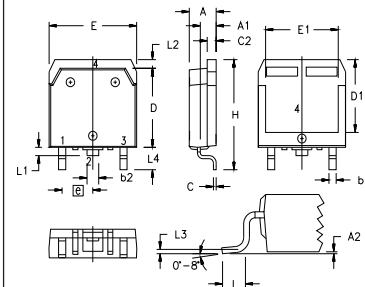

| SYM | INCHES | | MILLIMETERS | |
|----------------|--------|------|-------------|-------|
| | MIN | MAX | MIN | MAX |
| A | .193 | .201 | 4.90 | 5.10 |
| A ₁ | .106 | .114 | 2.70 | 2.90 |
| A ₂ | .001 | .010 | 0.02 | 0.25 |
| b | .045 | .057 | 1.15 | 1.45 |
| b ₂ | .075 | .083 | 1.90 | 2.10 |
| C | .016 | .026 | 0.40 | 0.65 |
| C ₂ | .057 | .063 | 1.45 | 1.60 |
| D | .543 | .551 | 13.80 | 14.00 |
| D ₁ | .488 | .500 | 12.40 | 12.70 |
| E | .624 | .632 | 15.85 | 16.05 |
| E ₁ | .524 | .535 | 13.30 | 13.60 |
| e | .215 | BSC | 5.45 | BSC |
| H | .736 | .752 | 18.70 | 19.10 |
| L | .094 | .106 | 2.40 | 2.70 |
| L ₁ | .047 | .055 | 1.20 | 1.40 |
| L ₂ | .039 | .045 | 1.00 | 1.15 |
| L ₃ | .010 | BSC | 0.25 | BSC |
| L ₄ | .150 | .161 | 3.80 | 4.10 |

IXYS Reserves the Right to Change Limits, Test Conditions, and Dimensions.

IXYS MOSFETs and IGBTs are covered 4,835,592 4,931,844 5,049,961 5,237,481 6,162,665 6,404,065 B1 6,683,344 6,727,585 7,005,734 B2 7,157,338B2
by one or more of the following U.S. patents: 4,850,072 5,017,508 5,063,307 5,381,025 6,259,123 B1 6,534,343 6,710,405 B2 6,759,692 7,063,975 B2
4,881,106 5,034,796 5,187,117 5,486,715 6,306,728 B1 6,583,505 6,710,463 6,771,478 B2 7,071,537

Fig. 1. Output Characteristics @ 25°C

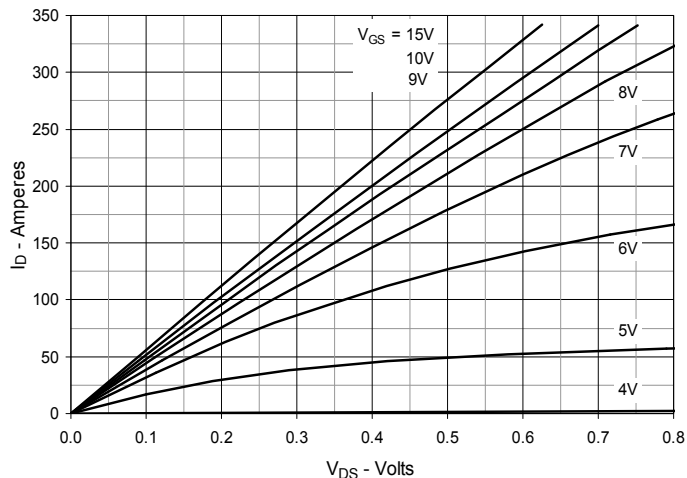

Fig. 2. Extended Output Characteristics @ 25°C

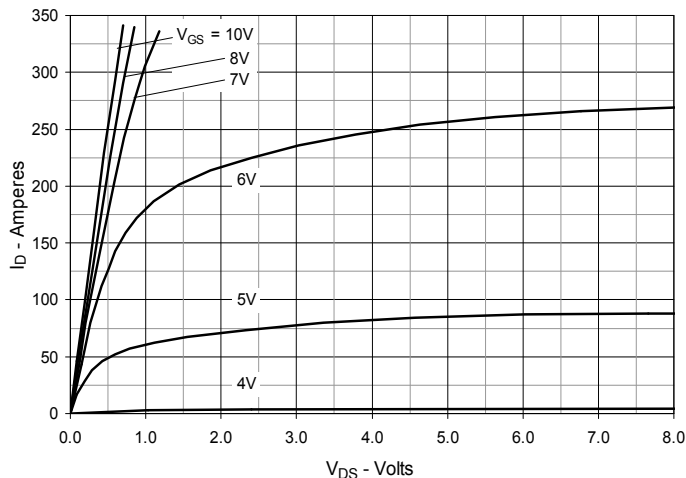

Fig. 3. Output Characteristics @ 150°C

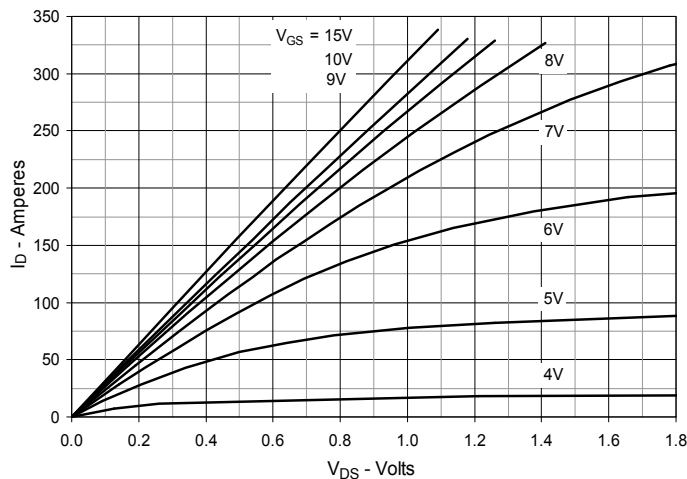

Fig. 4. $R_{DS(on)}$ Normalized to $I_D = 180A$ Value vs. Junction Temperature

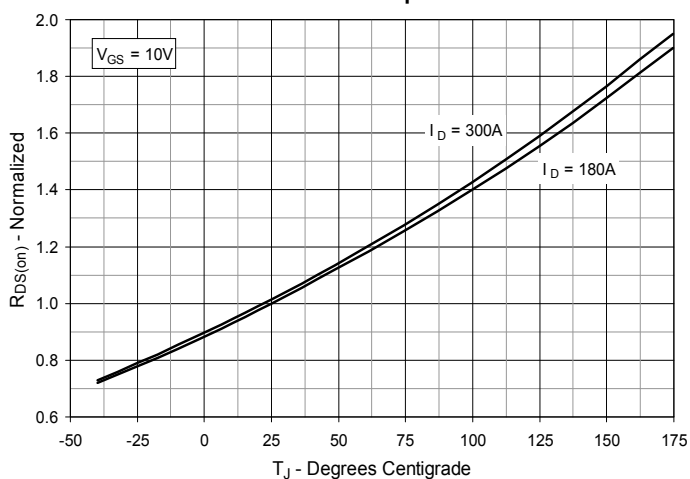

Fig. 5. $R_{DS(on)}$ Normalized to $I_D = 180A$ Value vs. Drain Current

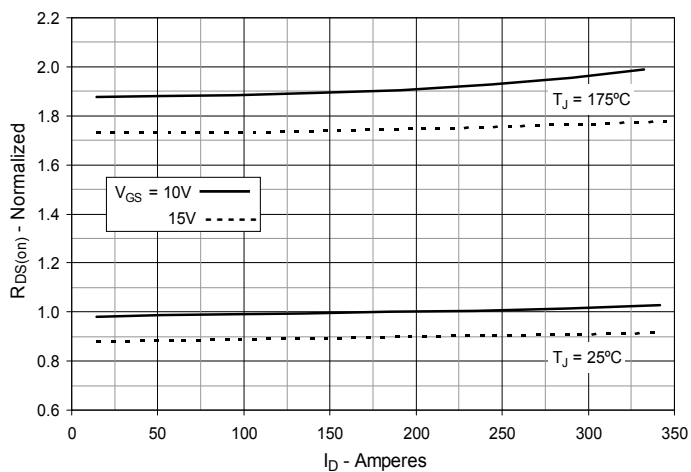

Fig. 6. Drain Current vs. Case Temperature

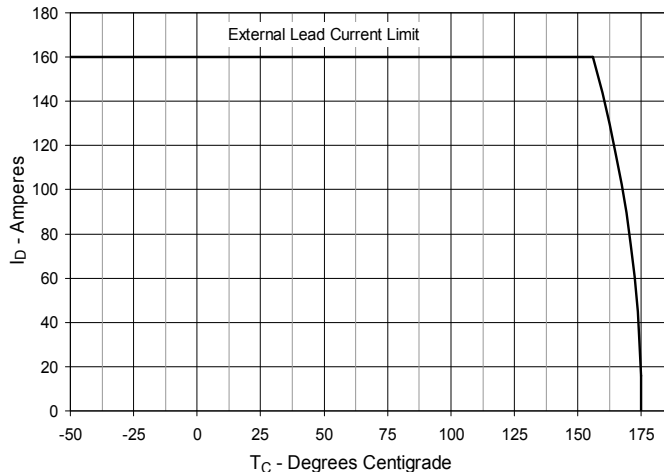

Fig. 7. Input Admittance

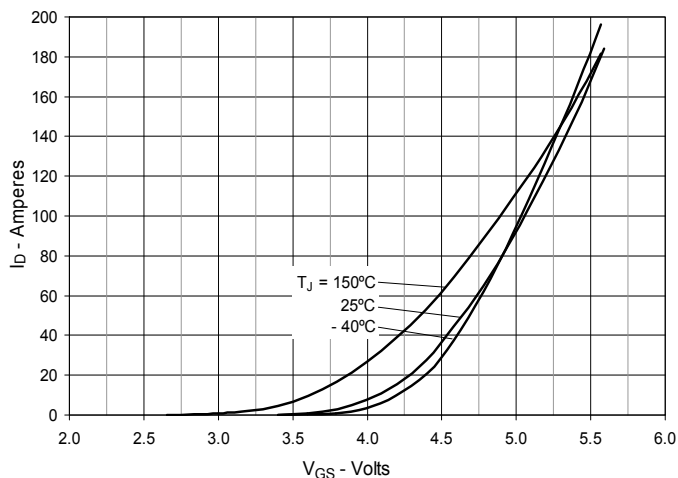

Fig. 8. Transconductance

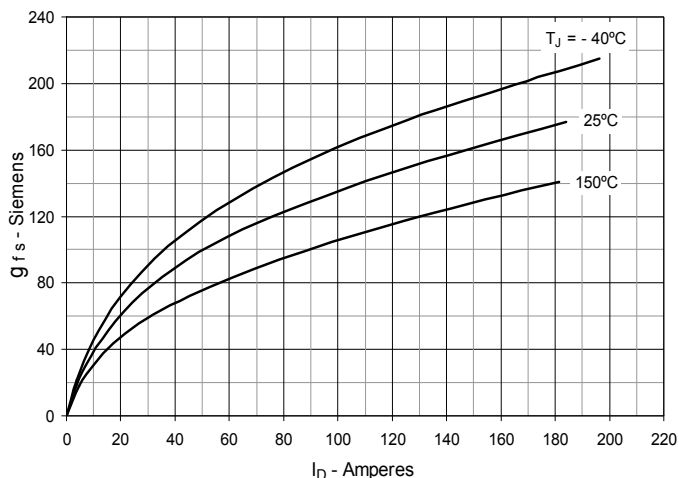

Fig. 9. Forward Voltage Drop of Intrinsic Diode

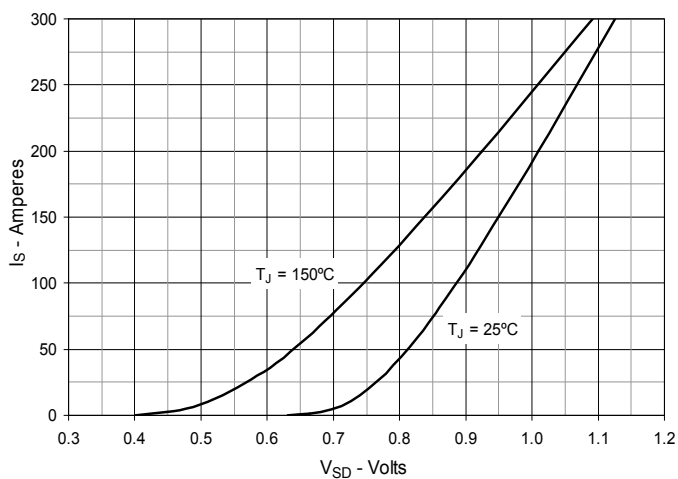

Fig. 10. Gate Charge

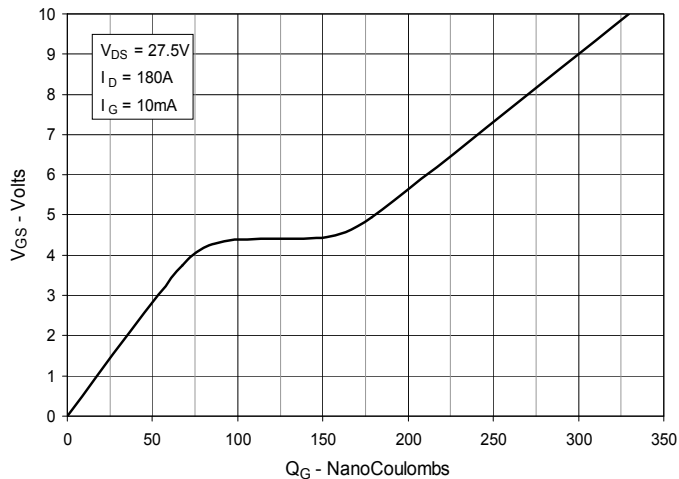

Fig. 11. Capacitance

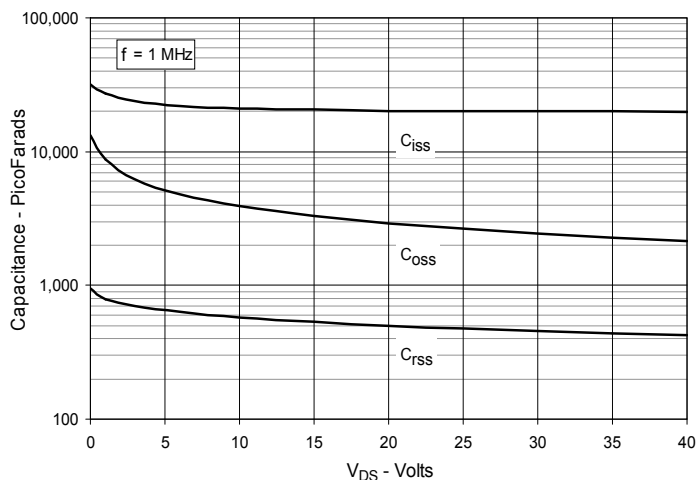

Fig. 12. Forward-Bias Safe Operating Area

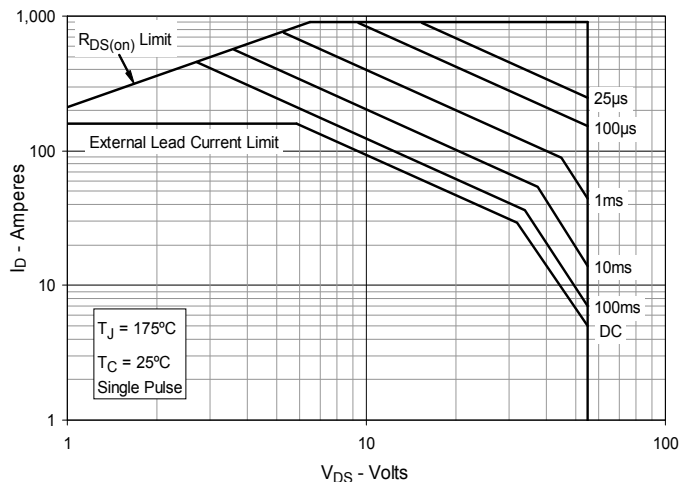

Fig. 13. Resistive Turn-on Rise Time vs. Junction Temperature

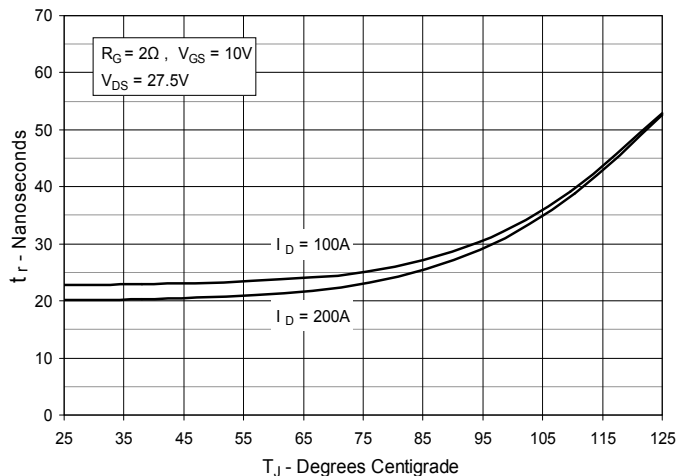

Fig. 14. Resistive Turn-on Rise Time vs. Drain Current

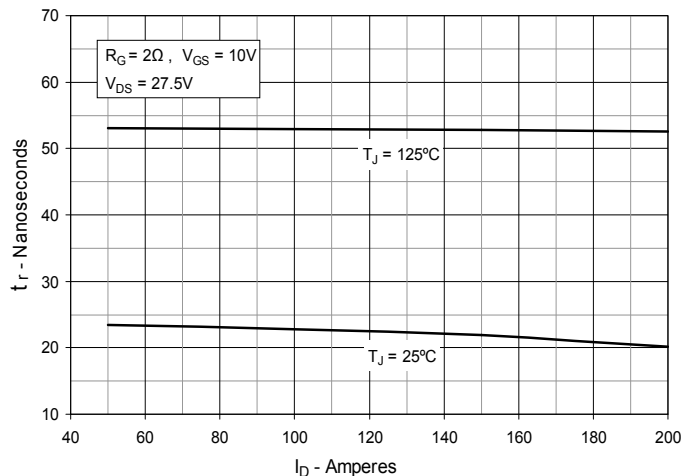

Fig. 15. Resistive Turn-on Switching Times vs. Gate Resistance

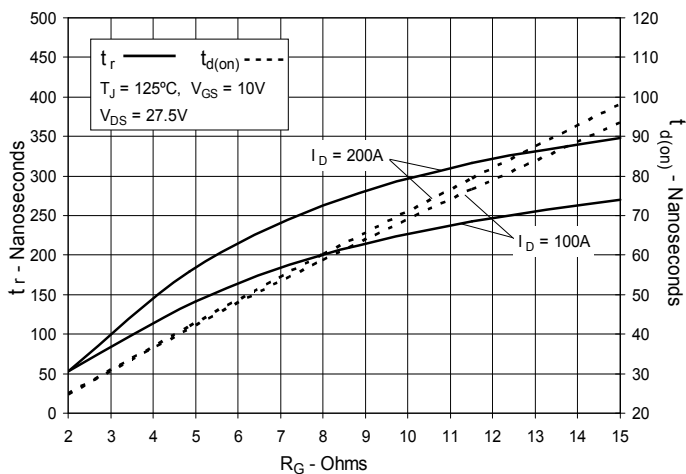

Fig. 16. Resistive Turn-off Switching Times vs. Junction Temperature

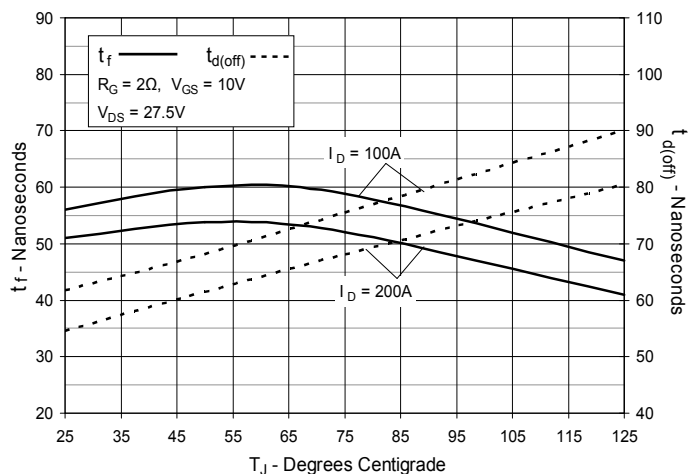

Fig. 17. Resistive Turn-off Switching Times vs. Drain Current

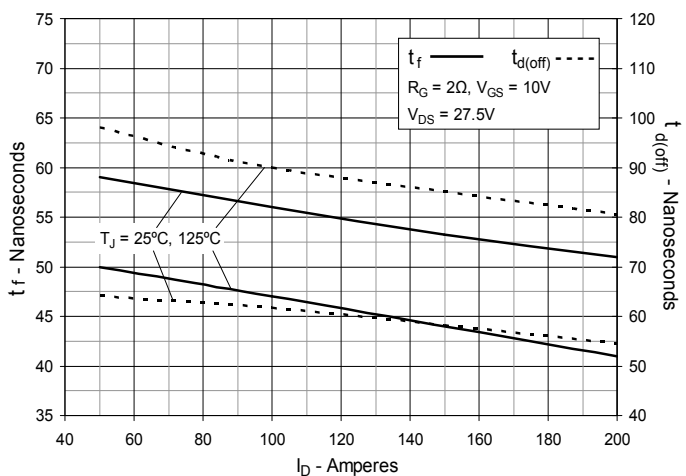

Fig. 18. Resistive Turn-off Switching Times vs. Gate Resistance

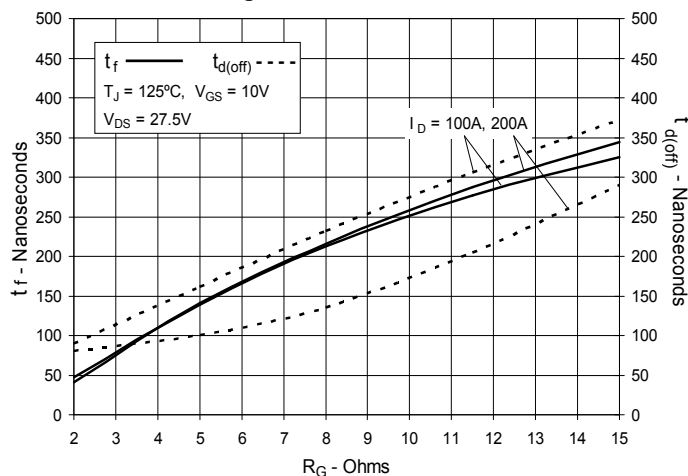

Fig. 19. Maximum Transient Thermal Impedance

