

80 W Motomate Right angle gearbox Part number 80081006



- Movement control for simple mechanisms
- All-in-one solution for quick integration
- Compact with high performance
- Intuitive programming with graphical function blocks
- Adapted for severe environments
- 12 pulses per revolution of the motor
- Independant torque control
- Uses the functionalities of TNI20

Part numbers

Type	Ratio	Max. speed (rpm)	Available torque (Nm)
------	-------	------------------	-----------------------

Specifications

General characteristics

Supply voltage (V)	24 (20 →37)
Max. current (A)	6
Immunity from micro power cuts (ms)	1
Operating temperature (°C)	-20 →+40
Protection index	IP 54

Programming

Inputs / outputs	4I/4O
Programming method	Function blocks / SFC
Program size	128
Program memory	Flash EEPROM
Program cycle time (ms)	10
Real-time clock	No

Logic inputs

Max. number	4 (I1 →I4)
Input impedance (kΩ)	> 10
Logic 1 voltage threshold (V)	> 15
Logic 0 voltage threshold (V)	< 5
Response time (ms)	10

High speed inputs

Max. number	2 (I1 →I2)
Max. frequency (k Hz)	4

Analogue input

Max. number	2 (I3 →I4)
Measurement range	0-10 VDC
Resolution	8 bits
Accuracy	± 5 %

Logic outputs / PWM

Max. number	4 (O1 →O4)
Type of output	PNP
Insulation	No
Max. current (mA)	250
Leakage current (mA)	< 0,1
Response time (ms)	10
PWM frequency (k Hz)	0.11 →1.8
PWM accuracy at 120 Hz	5 %

Accessories

Description	Code
Programming kit PC/Motomate - serial port	79 294 791
Programming kit PC/Motomate - USB	79 294 790
Programming software on CD ROM	79 294 792

Dimensions (mm)

Right angle gearbox



N°	Legend
1	Sensor output NPN

Applications

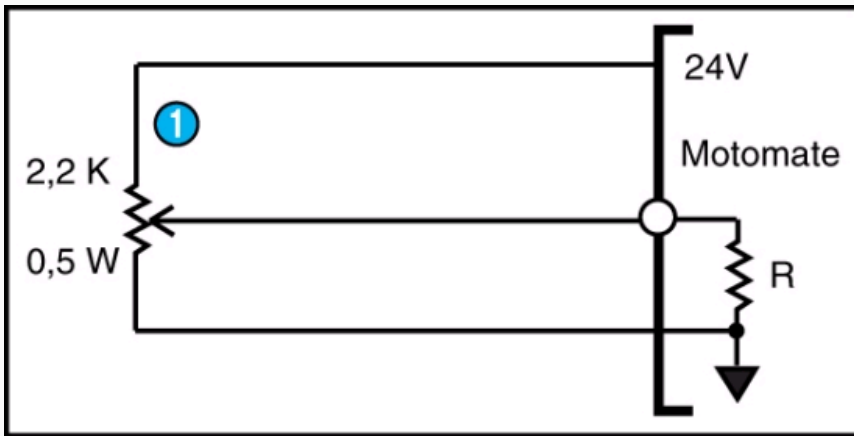

N°	Legend
1	Potentiometer

Applications

Examples of output connections

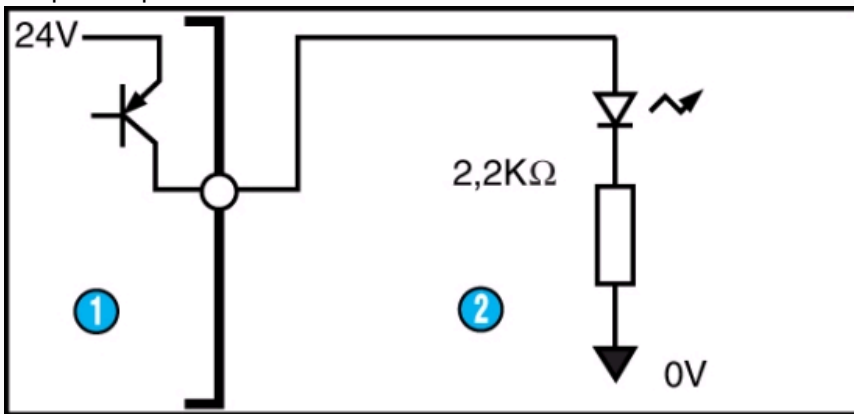

N°	Legend
1	Motor
2	Load LED

Applications

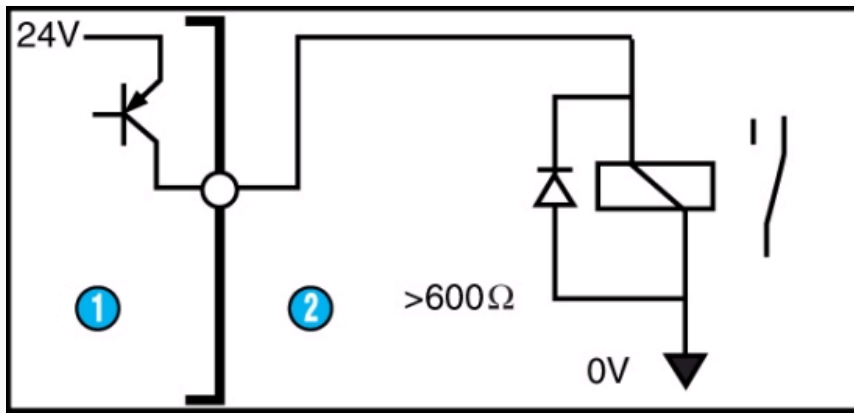

N°	Legend
1	Motor
2	Load relay

Product adaptations



- Special output shaft
- Special supply voltage
- Special cable length
- Customised electronics
- Special connectors
- Special gear ratios
- Special material for the gear wheels.
- Special mounting plate
- Customer programs installed at the factory