



Grayhill, Inc.

62S11-N4-PH

Part Number: 62S11-N4-PH

Fabrikant / Brand: Grayhill, Inc.

Produkt beschreibung: ROTARY ENCODER OPTICAL 32PPR

Datebanken: [PDF 62S11-N4-PH.pdf](#)RoHS Status:  Bleif gratis / RoHS kompatibel

Ship From: Hong Kong

Shipment Way: DHL/Fedex/TNT/UPS/EMS





Bild kann Representatioun sinn. Kuckt Spezifikatioune fir Produktdetailer.





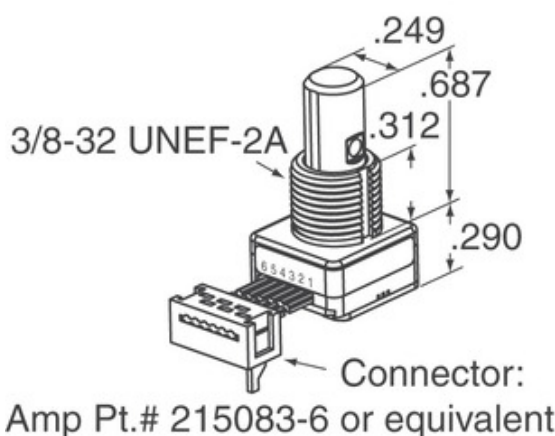

Spezifikatioune vun 62S11-N4-PH

PART NUMBER	62S11-N4-PH
HIERSTELLER	Grayhill, Inc.
BESCHREIWUNG	ROTARY ENCODER OPTICAL 32PPR
BLEIF FREE STATUS / ROHS STATUS	Bleif gratis / RoHS kompatibel
DATENLABEL	PDF 62S11-N4-PH.pdf
VOLTAGE - SUPPLY	5V
TERMINATIOUNSTIL	PC Pin
SERIE	62S
ROTATIONAL LIFE (CYCLES MIN)	1M
IMPULSEN PRO REVOLUTIOUN	32
AUSGÄNGEGKEET	Quadrature (Incremental)
ANER NAMES	62S11N4PH
ORIENTÉIERUNG	Vertical
MOUNTING TYPE	PCB, Through Hole
FEUCHTIGKEIT SENSIBILITÉITNIVEAU (MSL)	1 (Unlimited)
FABRIK STANDARD LEAD TIME	8 Weeks
BLEIF FREE STATUS / ROHS STATUS	Lead free / RoHS Compliant
ENCODER TYPE	Optical
PRËT	No
BUILT AM SCHALTER	Yes
AKTUATOR TYPE	1/4" Dia Flatted End

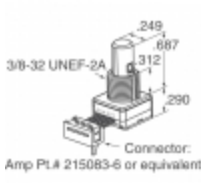
Verbonnen Tags

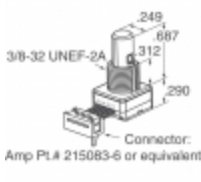
Grayhill, Inc. 62S11-N4-PH	62S11-N4-PH Distributeur	62S11-N4-PH Ubidder
62S11-N4-PH Präis	62S11-N4-PH Fotoen	62S11-N4-PH Bild
62S11-N4-PH PDF Dateblatt	62S11-N4-PH Luet Dateblatt	62S11-N4-PH Dateblatt
62S11-N4-PH Stock	Kaaft 62S11-N4-PH	Kaaft Grayhill, Inc. 62S11-N4-PH
Grayhill, Inc. 62S11-N4-PH	Grayhill, Inc. Ubidder	Grayhill, Inc. Distributeur
Grayhill, Inc. 62S11-N4-PH	Grayhill Inc. 62S11-N4-PH	

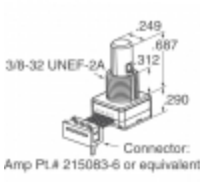
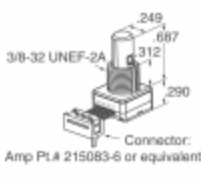
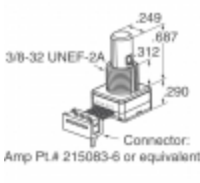
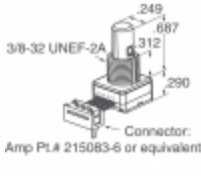
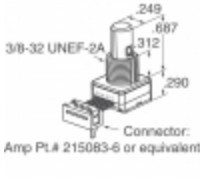
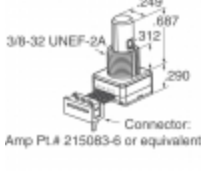
Verbonnen Produkter

 <p>62S11-N4-P Produzenteuren: Grayhill, Inc. Beschreibung: ROTARY ENCODER OPTICAL 32PPR Op Lager: Out stock RFQ</p>	 <p>62S11-N5-025C Produzenteuren: Grayhill, Inc. Beschreibung: ROTARY ENCODER OPTICAL 32PPR Op Lager: Out stock RFQ</p>
 <p>62S11-N4-120S Produzenteuren: Grayhill, Inc. Beschreibung: ROTARY ENCODER OPTICAL 32PPR Op Lager: Out stock RFQ</p>	 <p>62S11-N4-020C Produzenteuren: Grayhill, Inc. Beschreibung: ROTARY ENCODER OPTICAL 32PPR Op Lager: Out stock RFQ</p>
 <p>62S11-N5-025CH Produzenteuren: Grayhill, Inc. Beschreibung: ROTARY ENCODER OPTICAL 32PPR Op Lager: Out stock RFQ</p>	 <p>62S11-N5-050C Produzenteuren: Grayhill, Inc. Beschreibung: ROTARY ENCODER OPTICAL 32PPR Op Lager: Out stock RFQ</p>
 <p>62S11-N5-060C Produzenteuren: Grayhill, Inc. Beschreibung: ROTARY ENCODER OPTICAL 32PPR Op Lager: Out stock RFQ</p>	 <p>62S11-N5-040C Produzenteuren: Grayhill, Inc. Beschreibung: ROTARY ENCODER OPTICAL 32PPR Op Lager: Out stock RFQ</p>
 <p>62S11-N5-060SH Produzenteuren: Grayhill, Inc. Beschreibung: ROTARY ENCODER OPTICAL 32PPR Op Lager: Out stock RFQ</p>	 <p>62S11-N4-060SH Produzenteuren: Grayhill, Inc. Beschreibung: ROTARY ENCODER OPTICAL 32PPR Op Lager: Out stock RFQ</p>
 <p>62S11-N4-025CH Produzenteuren: Grayhill, Inc. Beschreibung: ROTARY ENCODER OPTICAL 32PPR Op Lager: Out stock RFQ</p>	 <p>62S11-N4-025C Produzenteuren: Grayhill, Inc. Beschreibung: ROTARY ENCODER OPTICAL 32PPR Op Lager: Out stock RFQ</p>