

Programmable Multi-Channel Driver PMD-35A-S

SLP-DUA4350AUS



Key Features

- Programmable, adjustable constant output current which can be adjusted to match LED module requirements and selectable various functions : 0-10V Classic, Native White Tuning(Select Mode, Continuous Mode), Dim to Warm.
- 0-10V Classic, two 0-10V inputs allow to control the two output currents of each within the limit of the max. power.
- Native White Tuning, the driver does the current mixing based on one input. That allows the PMD to do white color tuning with only two wall sliders. One 0-10V input sets the mix of warm to cool and another 0-10V input sets the brightness level.
- Dim to Warm, the driver does the current mixing and make CCT to become warmer as the brightness level reduced.

Basic Features

Series.	Part Number	Max. Power	Function	Input Voltage	Output Voltage	Output Current	Certification
PMD-35A-S	SLP-DUA4350AUS	35W	0-10V	120~277Vac	10~50Vdc	0.35~1.4A	cUL

- Certification : UL8750, UL Class2 Power, 47 CFR Part15 Subpart B
- Protections : Short Circuit, Over Temperature, Open Lamp, Over Voltage
- ta Range : -20 ~ +50 °C
- Expected Lifetime : 50,000 hours at tc = 70 °C

PMD Series

Series	Part Number	Max. Power	Function	Input Voltage	Output Voltage	Output Current	Certification
PMD-75C-LU	SLP-DUA47531WW	75W	0-10V, DALI	120~277Vac	10~50Vdc	0.35~1.4A	cUL, CE
PMD-75A-L	SLP-DUA47501US	75W	0-10V	120~277Vac	10~50Vdc	0.35~1.4A	cUL
PMD-75D-L	SLP-D2A475D1EU	75W	DALI	220~240Vac	10~50Vdc	0.35~1.4A	CE, ENEC
PMD-75D-LU	SLP-DUA475D1US	75W	DALI	120~277Vac	10~50Vdc	0.35~1.4A	cUL
PMD-55A-L	SLP-DUA45501US	55W	0-10V	120~277Vac	10~50Vdc	0.35~1.4A	cUL
PMD-55D-L	SLP-D2A455D1EU	55W	DALI	220~240Vac	10~50Vdc	0.35~1.4A	CE, ENEC
PMD-55D-LU	SLP-DUA455D1US	55W	DALI	120~277Vac	10~50Vdc	0.35~1.4A	cUL
PMD-55A-S	SLP-DUA4550AUS	55W	0-10V	120~277Vac	10~50Vdc	0.35~1.4A	cUL
PMD-35A-L	SLP-DUA43501US	35W	0-10V	120~277Vac	10~50Vdc	0.35~1.4A	cUL
PMD-35D-L	SLP-D2A435D1EU	35W	DALI	220~240Vac	10~50Vdc	0.35~1.4A	CE, ENEC
PMD-35D-LU	SLP-DUA435D1US	35W	DALI	120~277Vac	10~50Vdc	0.35~1.4A	cUL
PMD-35A-S	SLP-DUA4350AUS	35W	0-10V	120~277Vac	10~50Vdc	0.35~1.4A	cUL
PMD-25A-S	SLP-DUA0250AUS	25W	0-10V	120~277Vac	10~50Vdc	0.35~1.0A	cUL
PMD-25D-SU	SLP-DUA025DAWW	25W	DALI	120~277Vac	10~50Vdc	0.35~1.0A	cUL, CE, ENEC

Table of Contents

1.	Electrical Specification	-----	4
2.	Enclosure	-----	5
3.	Label	-----	6
4.	Connector	-----	6
5.	Packing	-----	7
6.	Protection	-----	8
7.	Operating Window	-----	9
8.	Performance	-----	9
9.	Precautions	-----	11

1. Electrical Specification

Article	Symbol	Specification			Unit	Note
		Min.	Typ.	Max.		
INPUT SPECIFICATIONS						
Nominal Voltage	V _{in}	120		277	Vac	Full input range
Voltage Range		108		305	Vac	
Nominal Frequency	f _{in}	50		60	Hz	
Frequency Range		47		63	Hz	
Input Current	I _{in}			0.4	A	@ 120Vac
Input Current	I _{in}			0.18	A	@ 277Vac
Total Harmonic Distortion	THD			20	%	@ full load, 120-277 Vac
Power Factor	PF	0.9			-	@ full load, 120-277Vac
Efficiency	H	83	85		%	@ full load, 120-277 Vac,
Protection Class			I		-	PE can be connected to either terminal or housing
Inrush Current				20	A _{pk}	t _{width} = Typ. 300 μs @ 50% I _{peak}
OUTPUT SPECIFICATIONS						
Nominal Voltage	V _o	10		50	Vdc	See graph
Nominal Current	I _o	0.35		1.4	A	2channel ±5 % tolerance (@ max current)
Current Ripple				30	%	Output current ± 30%
Nominal Power	P _o			35	W	Output wattage
Auxiliary Power Voltage			24		V	For nIO Supply Power
Auxiliary Power Current				100	mA	For nIO Supply power
Turn on delay time	T _d			1.0	s	AC on 90%
Dimming SPECIFICATIONS						
Control 1			1 - 10			Analog
Control 1 Range			1 - 100		%	
Dimming Technique			PWM			
Standby Power				0.5	W	Dimming Off

Article	Symbol	Specification			Unit	Note
		Min.	Typ.	Max.		
ENVIRONMENTAL SPECIFICATIONS						
Ambient Temperature	t_a	-20		50	°C	
Case Temperature	t_c			70	°C	Measured at t_c point as indicated on the product label
Storage Temperature	t_s	-20		85	°C	Cool down before operating
Relative Humidity		20		95	%	Not condensing
Surge Transient Protection	L / N			±2	kV	According to EN 61547
	LN / GND			±4	kV	
IP Rating			20		-	Suitable for indoor environment
Expected Lifetime		50,000			h	$t_c = 70\text{ °C}$, full load
Dimensions	L x W x H		127 x 76.4 x 29.8		mm	
Net Weight			330		g	± 10%

2. Enclosure

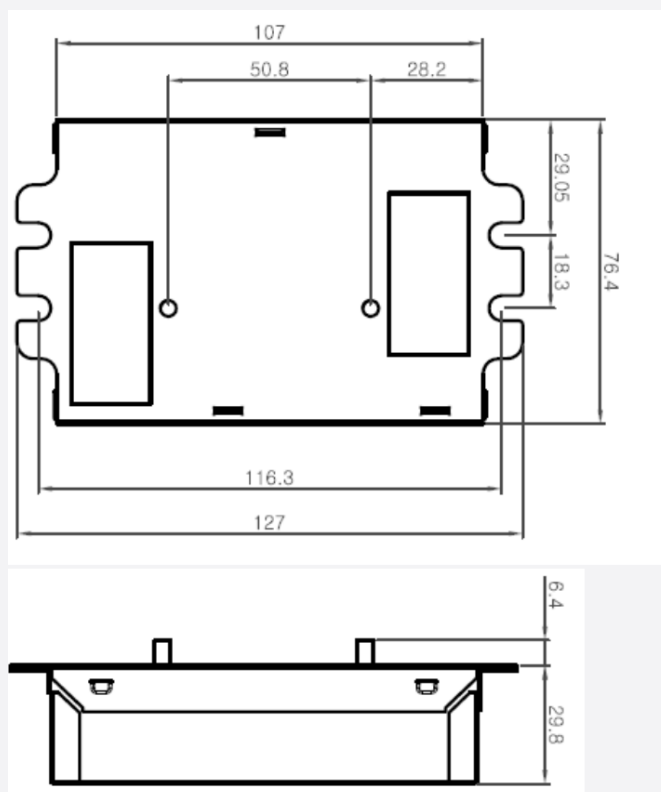

3. Label

SAMSUNG Tc.

PMD(Programmable Multichannel Driver)
SLP-DUA4350AUS

Vin : 120 – 277 V~ Vout : 10 – 50V ---
 Iin : 0.4A Iout : 0.35 – 1.4A
 Freq : 50/60Hz Vaux : 24V --- Iaux : 0.1A
 PF : > 0.90C Pout : Max. 35W



E470825

wire preparation
 push in
 0.2 – 0.75 

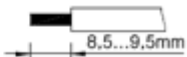

Block Connection

(GREEN)	P.E	Current Setting	GND	(GRAY)
			24V	(YELLOW)
			ADIM2+	(PURPLE)
(WHITE)	NEUTRAL		ADIM1+	(PURPLE)
			LED2-	(BLACK)
			LED2+	(RED)
			LED1-	(BLACK)
(BLACK)	LIVE		LED1+	(RED)

S/N

Made in Korea
 Made in China
 GROUNDING
 Driver case must be grounded

4. Connector

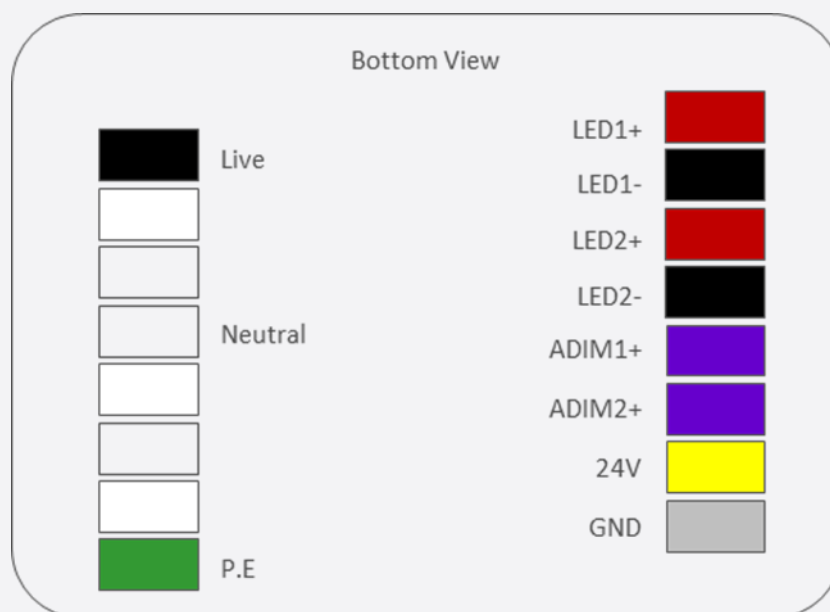

5. Packing

Material	Quantity (Max. pcs)	Dimension (mm)		
		Length	Width	Height
Outer Paper Box	40	571	347	211

- Pallet
 - 1100 x 1100 x 1200mm
 - 1 Pallet : 20 Box = PSU 800ea (4 Box x 5 Floor)

- Box

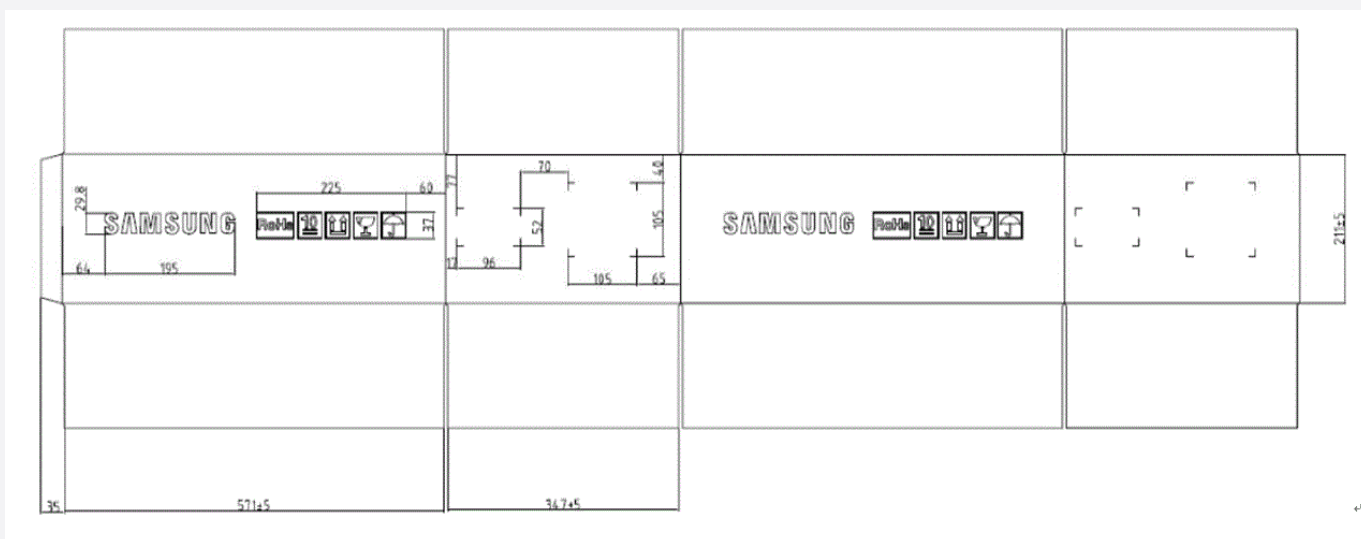

- Box Label

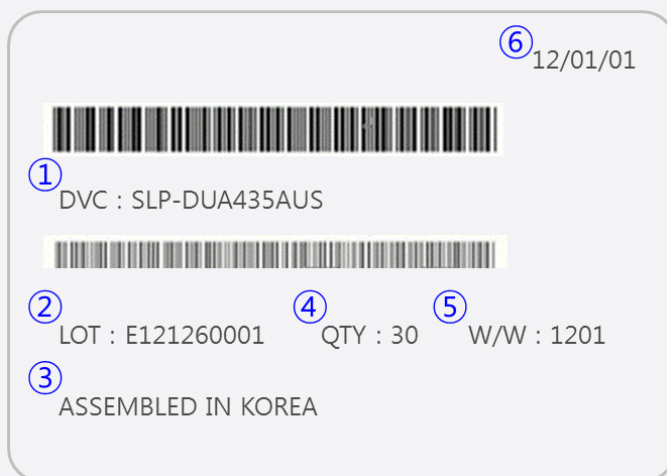

6. Protection

- ① Model Code
- ② Lot No.
- ③ Origin
- ④ Packing Quantity
- ⑤ Date of Manufacture (Weekly)
- ⑥ Date of Manufacture (Daily)



Items	Symbol	Condition	Function
Over Temperature Protection	OTP	Vin = Rated Voltage, Temp. exceeds 150 °C	Current decreases (Auto Recovery)
Short Circuit Protection	SCP	Vin = Rated Voltage, LED short	No Output (Auto Recovery)
Open Lamp Protection	OLP	Vin = Rated Voltage, LED open	Vout = 60V Clamp (Auto Recovery)
Over Voltage Protection	OVP	Vin = Rated Voltage, F/B Open or Short	Vout = 60V Clamp (Auto Recovery)

7. Operating Window

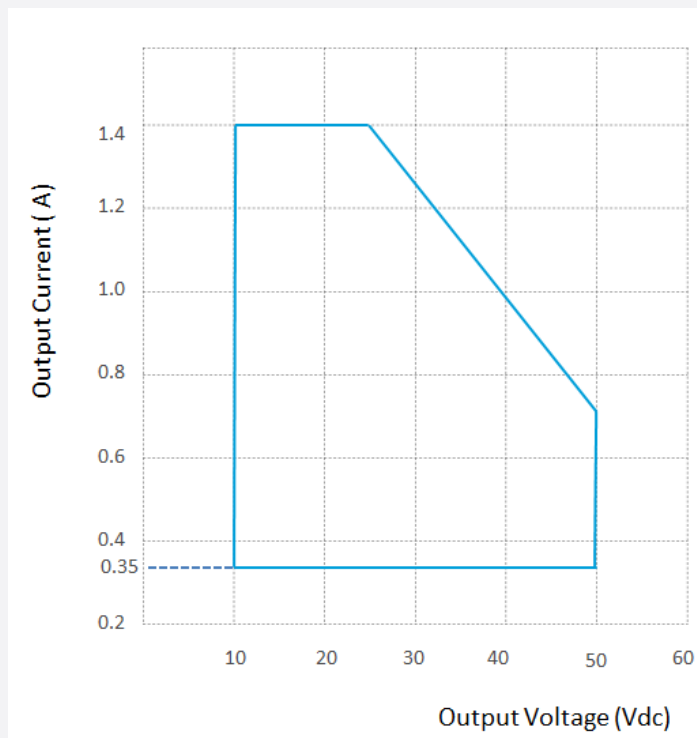

8. Performance

- Tested with connected LED load , Programmed for 1,400mA and at 25 °c ambient temperature.
- Efficiency

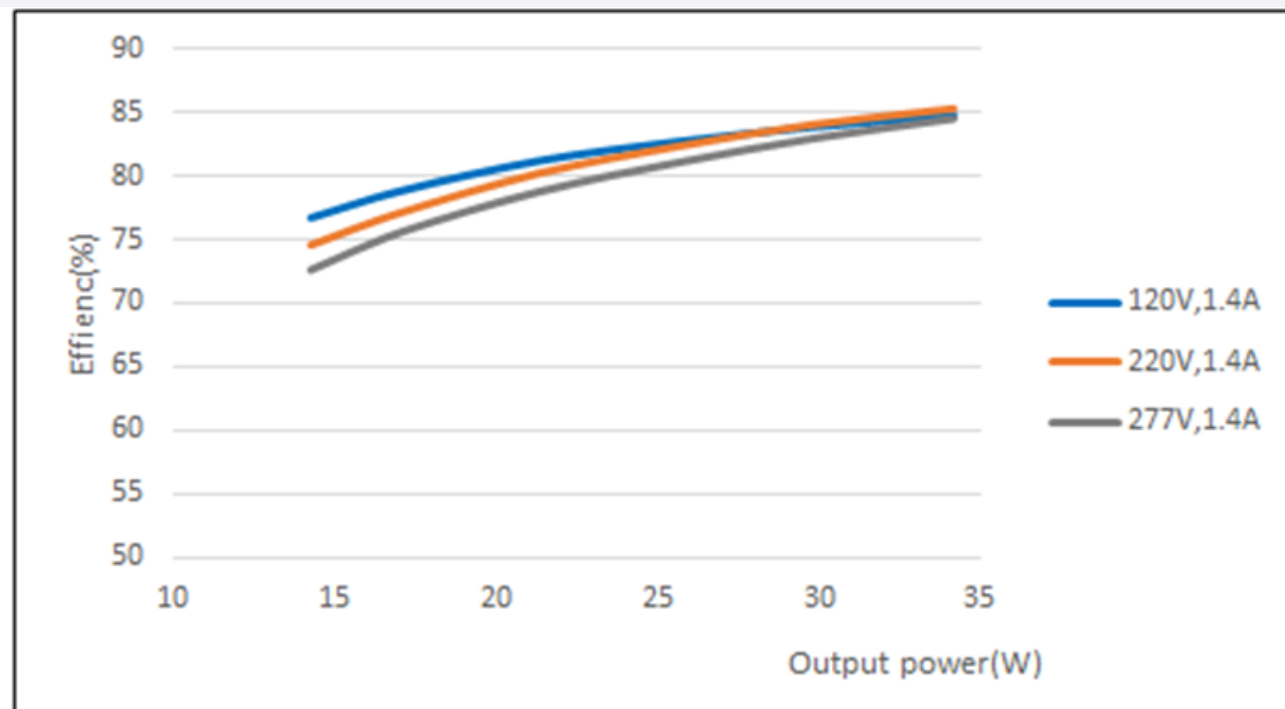

- Power Factor

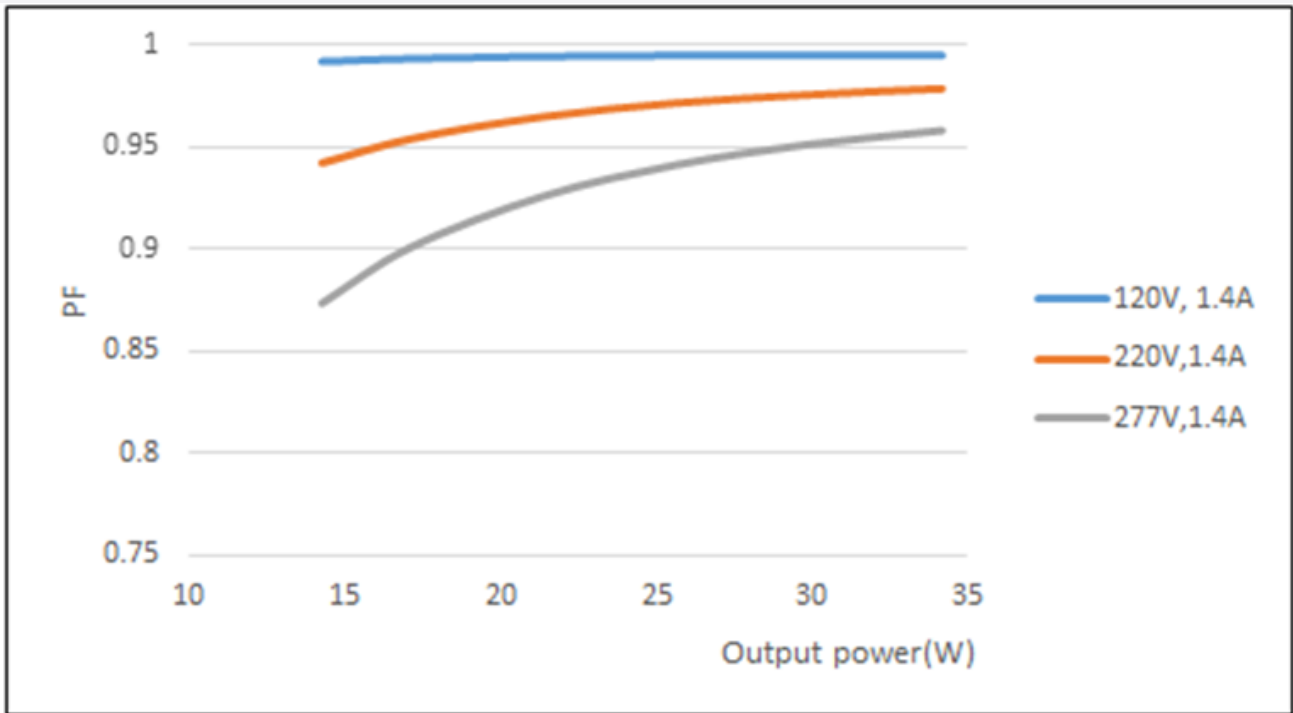

- Total Harmonic Distortion

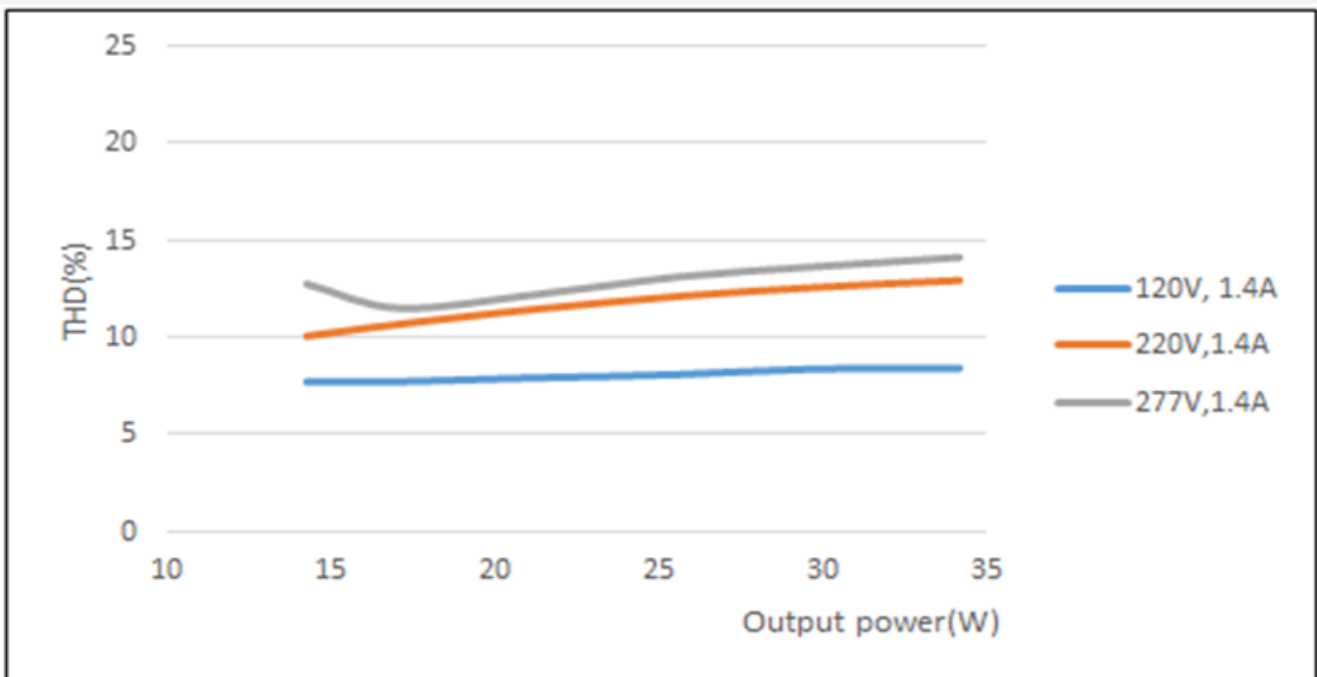

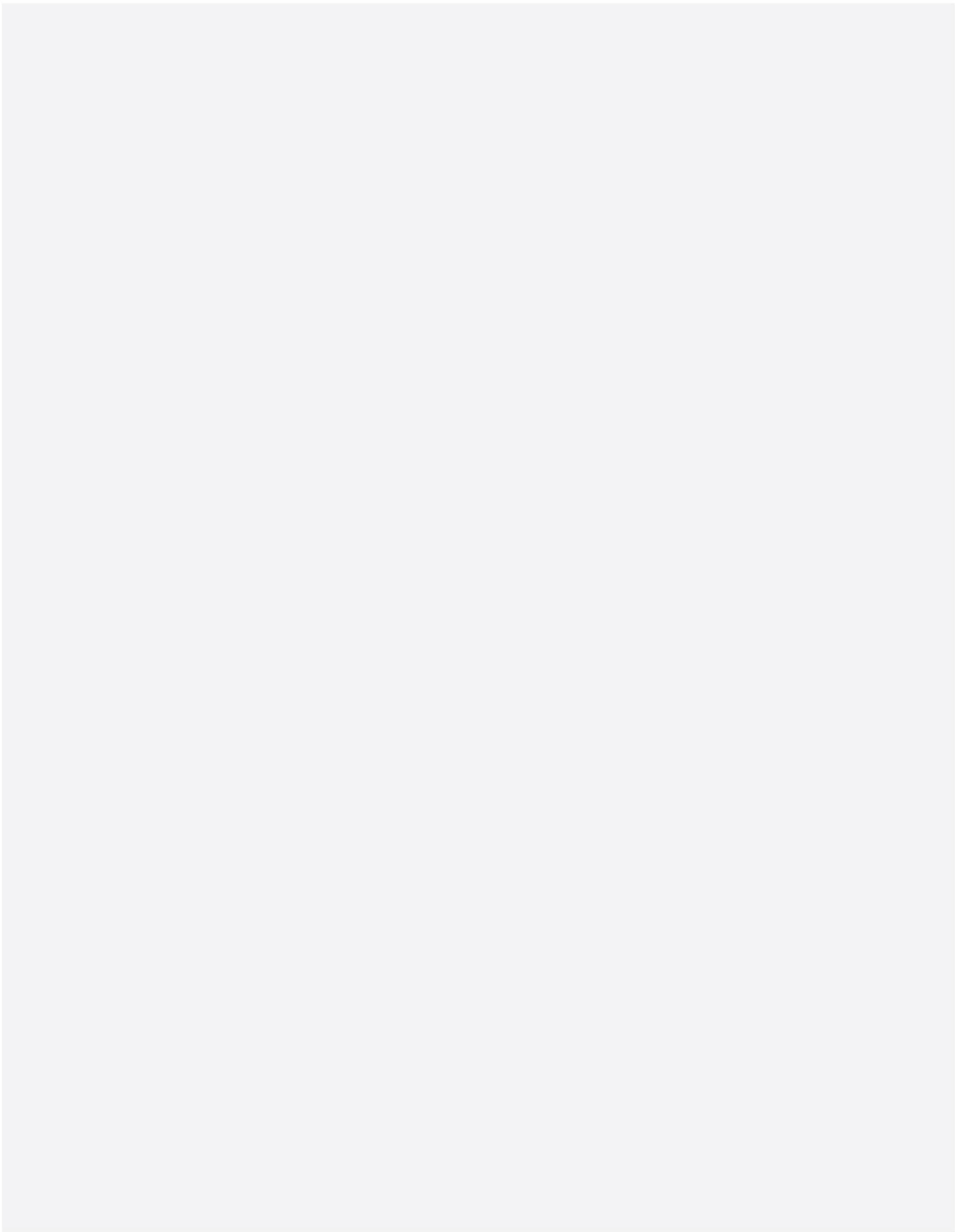

9. Precaution

- To prevent the LED Driver from any defect, please handle and store it with care
 - Do not drop or give shock
 - Do not store in very humid location or at extreme temperature
 - Do not open or disassemble the product
- Static electricity or surge voltage may damage the components inside LED Driver, as such please observe proper anti-electrostatic working process
 - People handling the Driver should be well grounded (e.g. using ESD wrist band) and wear anti-static working clothes and gloves
 - All related devices and instruments in the production line should be well grounded (e.g. working table, measuring equipment, assembly jigs)
- Incorrect installation of the LED driver can cause irreparable damage to the LED driver and the connected LEDs. Pay attention when connecting the LEDs: polarity reversal results in damages the LED driver
 - Observe the correct polarity of output terminal : Please refer to the connection diagram as below

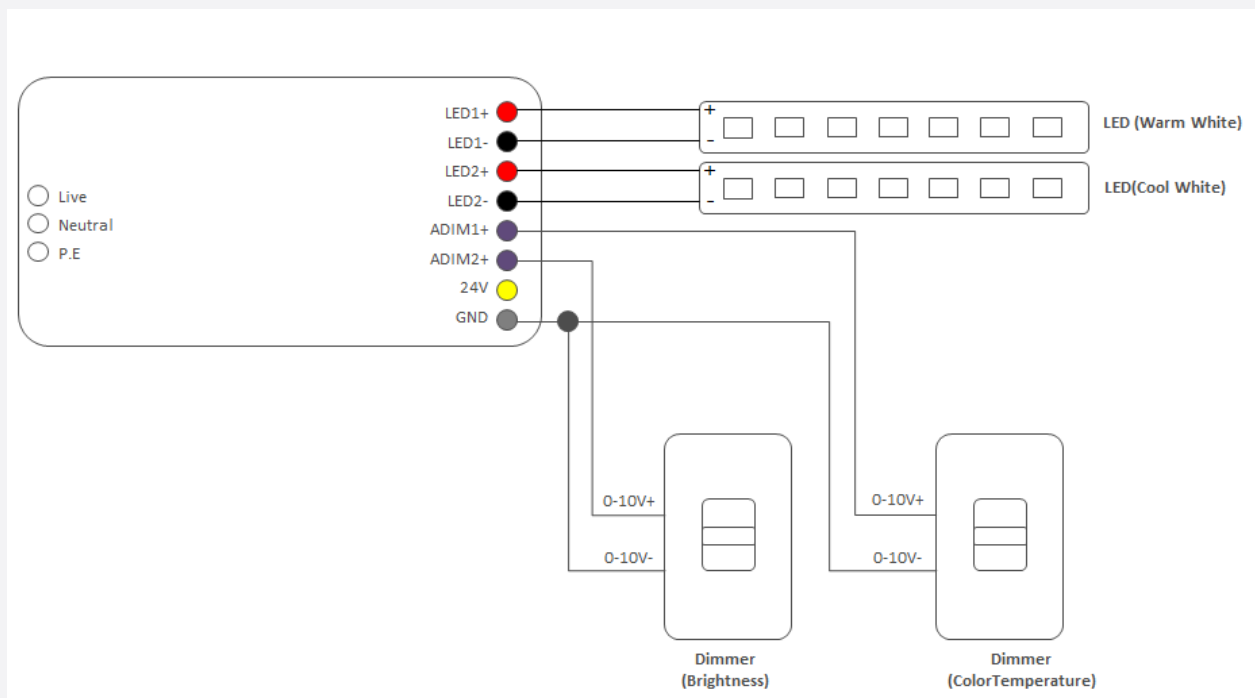

- Avoid input voltage exceeds the maximum rating, which will cause damage to the circuit and result in malfunction
- Specifications are subject to change without notice

Legal and additional information.

About Samsung Electronics Co., Ltd.

Samsung Electronics Co., Ltd. inspires the world and shapes the future with transformative ideas and technologies.

The company is redefining the worlds of TVs, smartphones, wearable devices, tablets, cameras, digital appliances, medical equipment, network systems, and semiconductor and LED solutions. For the latest news, please visit the Samsung Newsroom at news.samsung.com.

Copyright © 2016-2017 Samsung Electronics Co., Ltd. All rights reserved.

Samsung Electronics reserves the right to modify, at its sole discretion, the design, packaging, specifications, and features shown herein without notice at any time.

Samsung Electronics Co., Ltd.
95, Samsung 2-ro, Giheung-gu
Yongin-si, Gyeonggi-do, 446-711
KOREA

www.samsungled.com

